

FINISH: ZINC PLATE & POWDER COAT  
 WEIGHT: 78.16Kg

FINISH: ZINC PLATE AND POWDER COAT

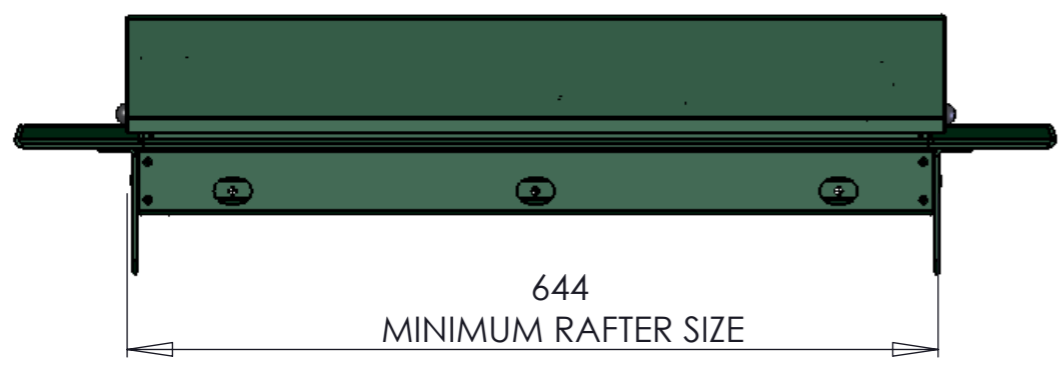

|  |             |                     |  |                  |
|--|-------------|---------------------|--|------------------|
|  | NAME        | DATE                | MATERIAL: MILD STEEL                           | Sheet Scale: 1:6 |
| DRAWN  | SHAUN COUCH | 11/02/2011          |  | SHEET 1 OF 3     |
| APPROVED   |             |                     | PART REF: ROOFLIGHT GA - CLOSED                |                  |
| <b>LUMEN</b><br>ROOFLIGHT  |             | TEL. (08453) 308859 | TITLE: CONTEMPORARY ROOFLIGHT GENERAL ASSEMBLY |                  |
|  |             | FAX. (08453) 307260 |  |                  |
| UNLESS OTHERWISE SPECIFIED DIMENSIONS ARE IN MILLIMETERS<br>ANGLE ±0.5° / 0.0 ±0.25mm / 0.00±0.1mm / 0.000 ±0.05mm |             |                     | SIZE: DRWG No.                                 | Rev No.          |
|  |             |                     | A3 TUS0997A                                    | 2                |

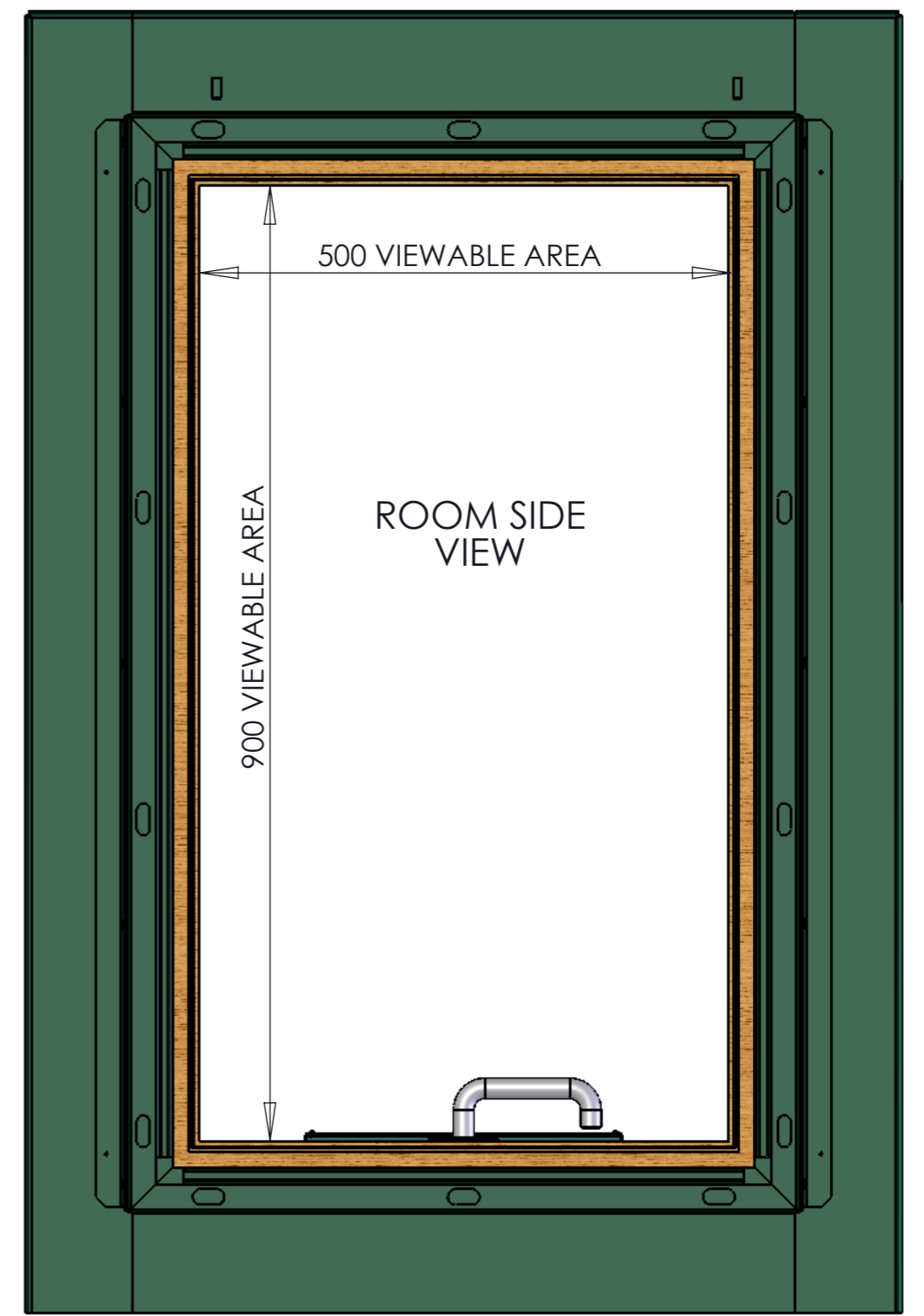
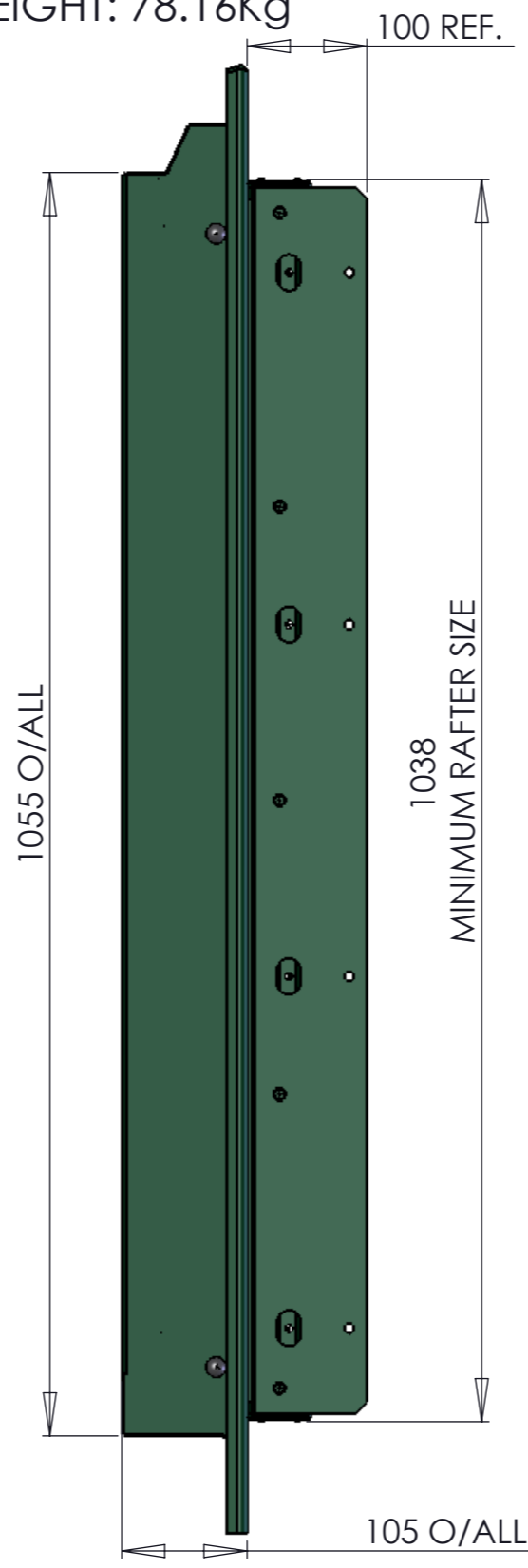
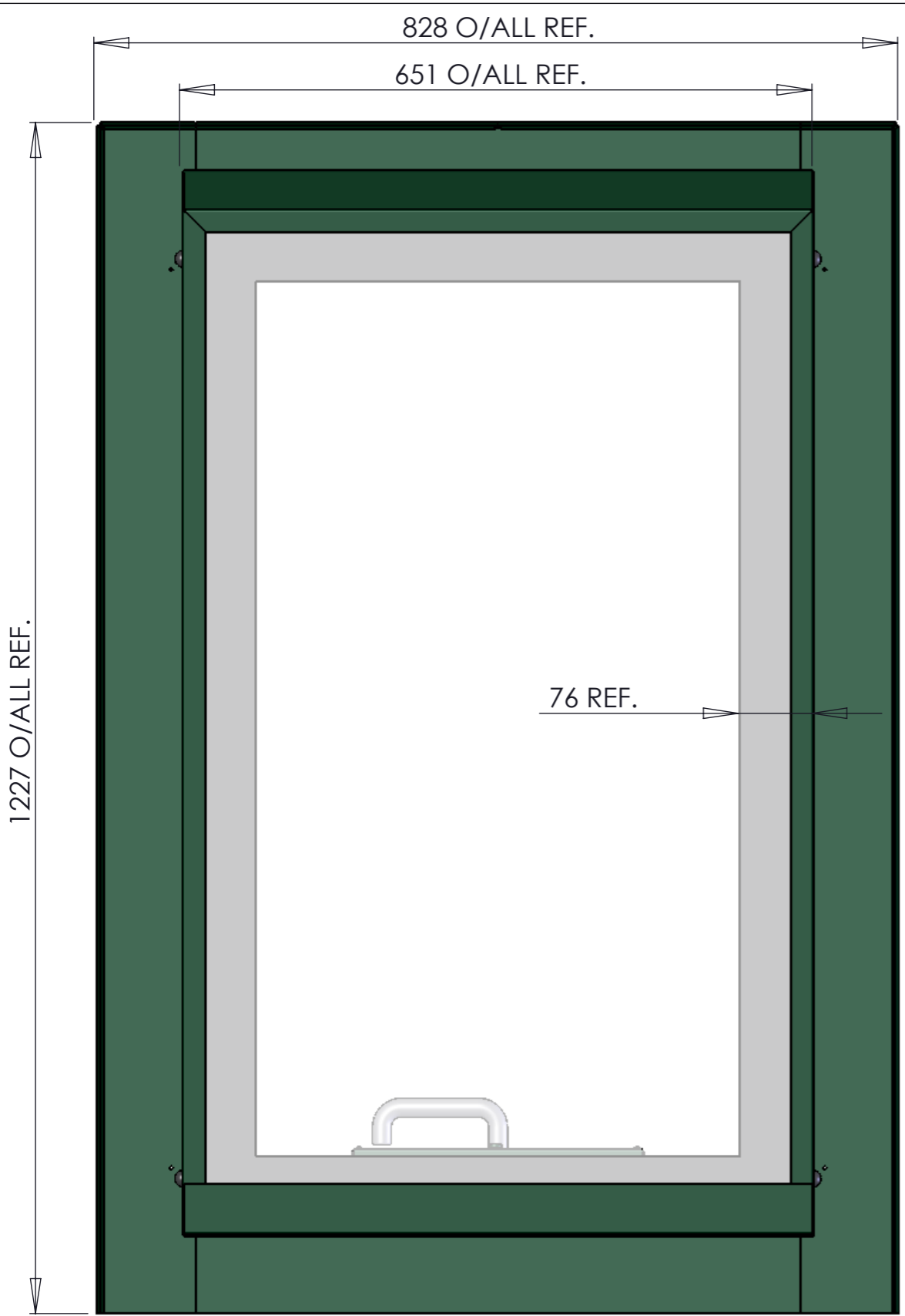
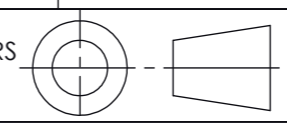

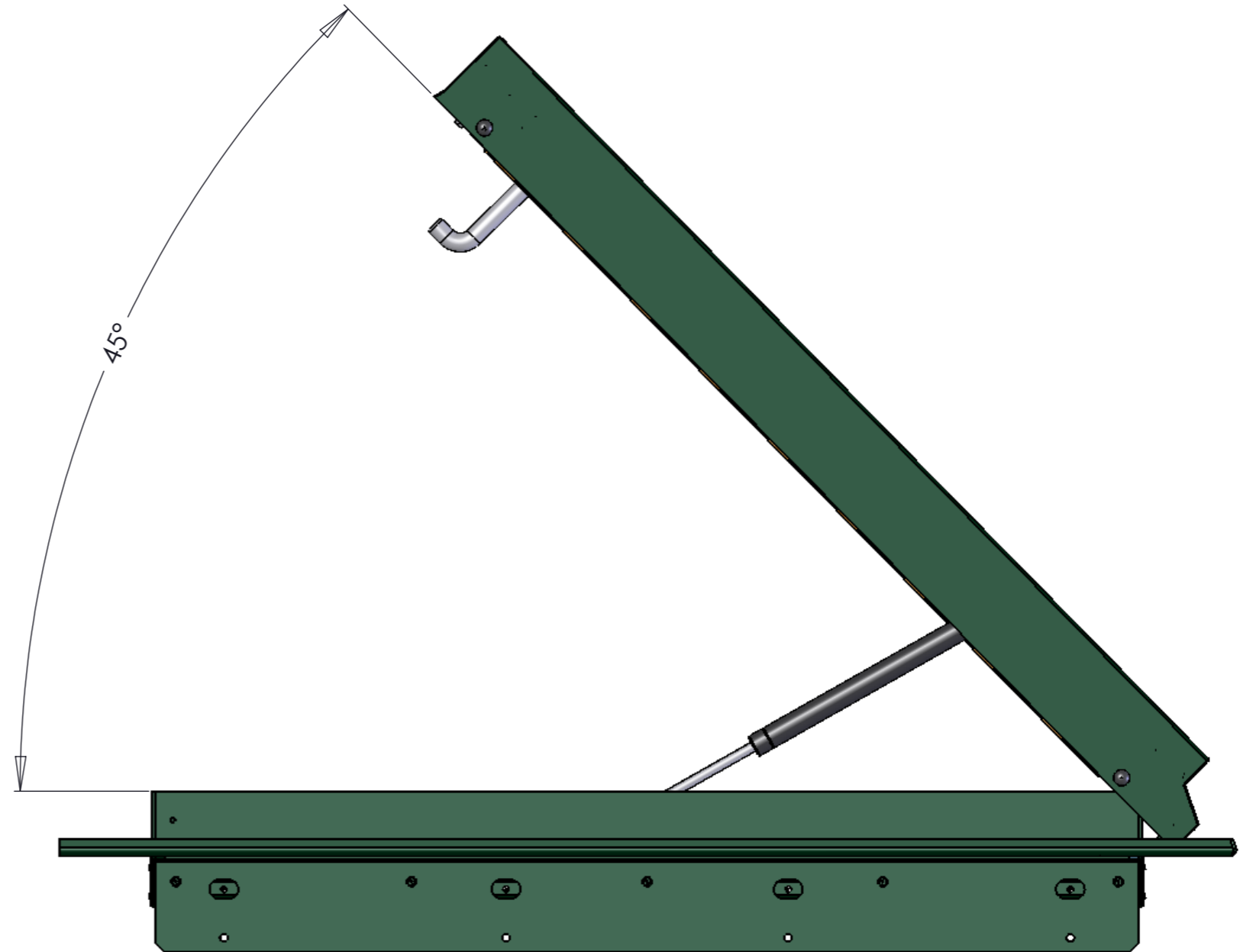
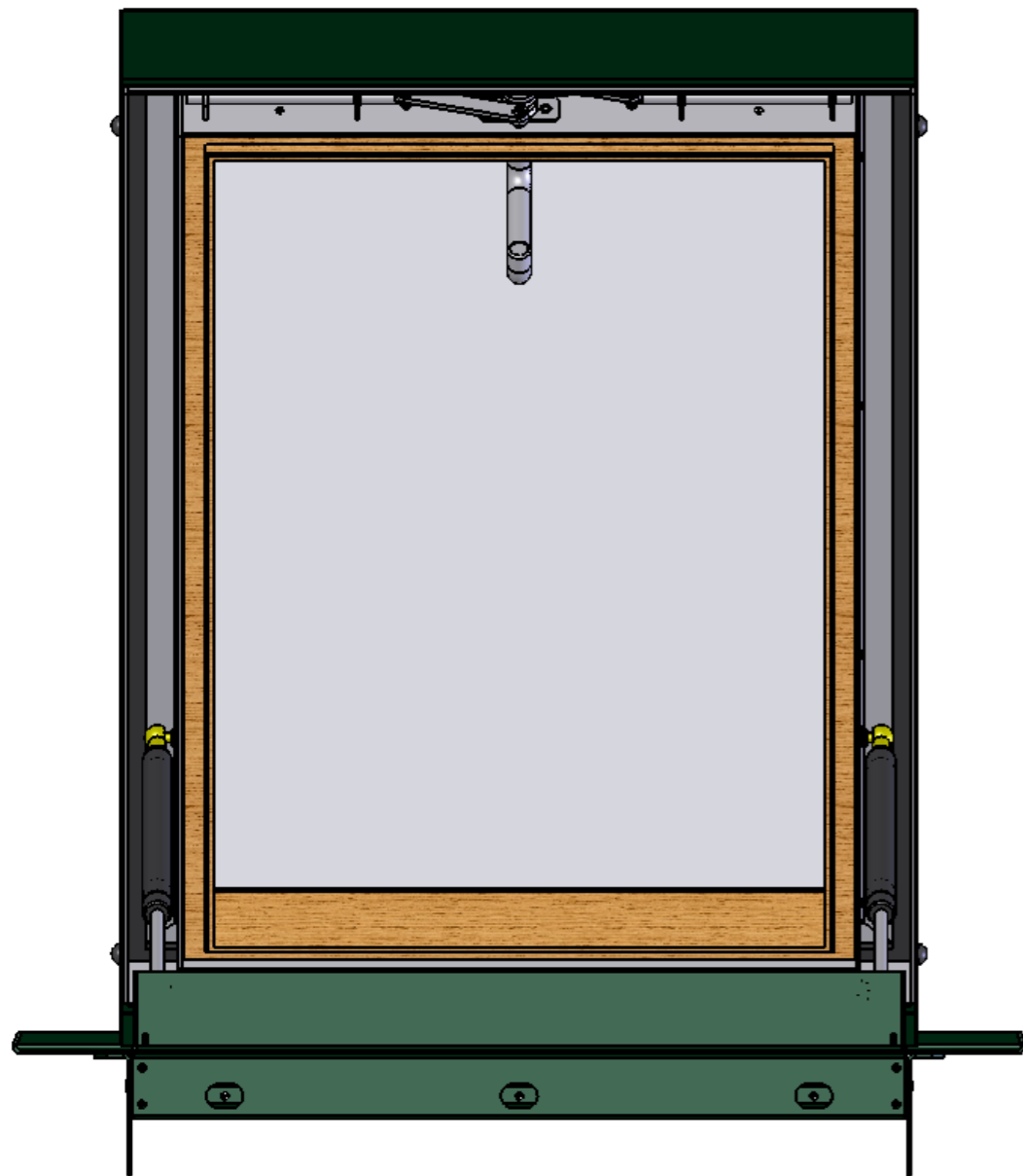

ROOFLIGHT SHOWN IN OPEN POSITION

|   |             |                     |                               |                  |
|---|-------------|---------------------|-------------------------------|------------------|
|   | NAME        | DATE                | MATERIAL: MILD STEEL          | Sheet Scale: 1:6 |
| DRAWN   | SHAUN COUCH | 11/02/2011          |                               | SHEET 2 OF 3     |
| APPROVED  |             |                     | PART REF: ROOFLIGHT GA - OPEN |                  |
| <b>LUMEN</b>  |             | TEL. (08453) 308859 | TITLE: CONTEMPORARY ROOFLIGHT |                  |
| ROOFLIGHT   |             | FAX. (08453) 307260 | GENERAL ASSEMBLY              |                  |
| UNLESS OTHERWISE SPECIFIED<br>DIMENSIONS ARE IN MILLIMETERS |             |                     | SIZE: DRWG No.                | Rev No.          |
| ANGLE ±0.5° / 0.0 ±0.25mm /<br>0.00±0.1mm /0.000 ±0.05mm    |             |                     | A3 TUS0997A                   | <b>2</b>         |

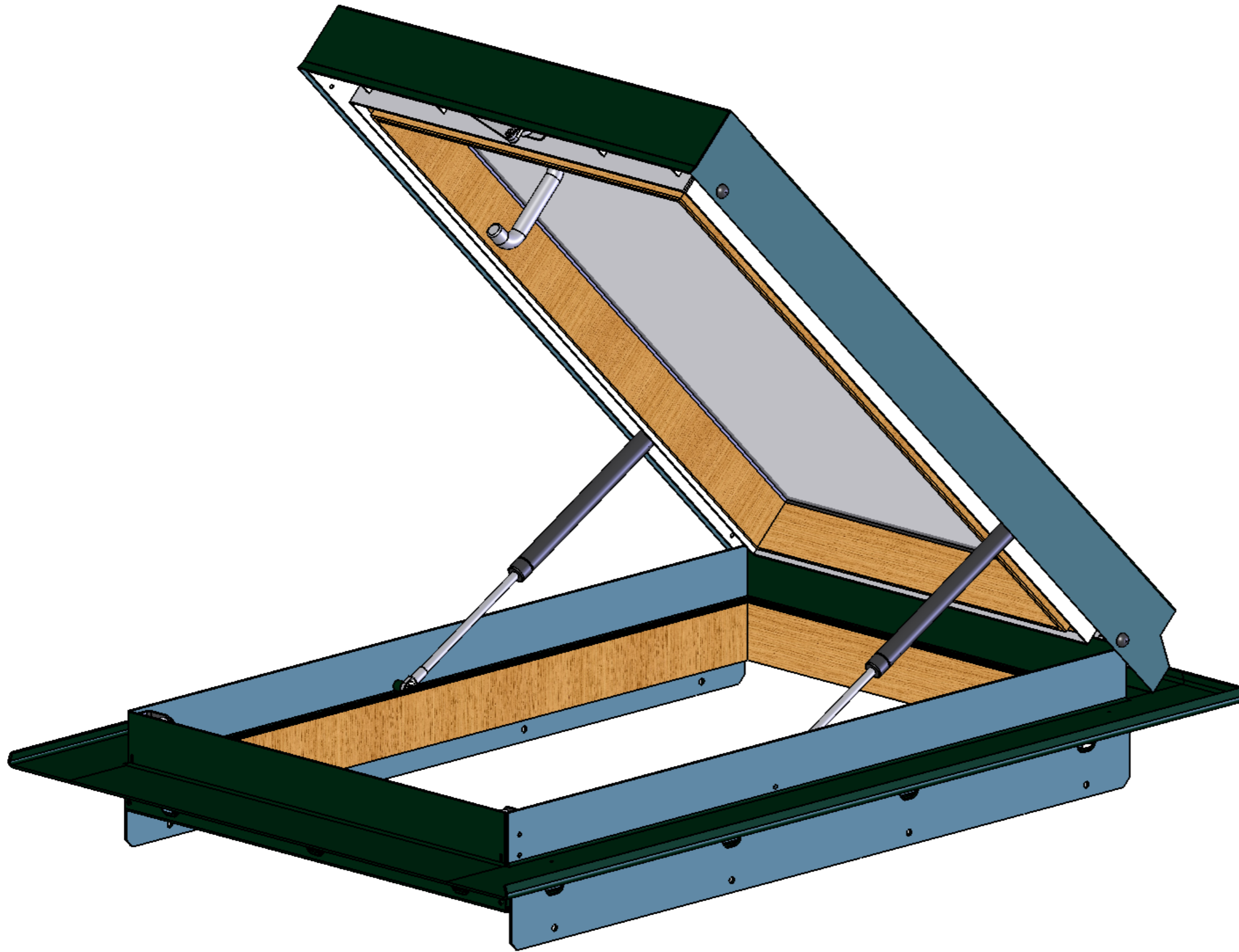

| ITEM NO. | PART NUMBER                  | QTY. |
|----------|------------------------------|------|
| 1        | Outer Frame GA               | 1    |
| 2        | Casement GA                  | 1    |
| 3        | TUS0116P                     | 8    |
| 4        | M8 Nylock Nut - ST STEEL     | 2    |
| 5        | GS-0-8400 Gas Strut Assembly | 2    |
| 6        | External Circlip M8 x 0.8    | 2    |
| 7        | Flat Washer M8               | 4    |

|  |             |                     |                     |  |                  |
|--|-------------|---------------------|---------------------|--|------------------|
| DRAWN  | SHAUN COUCH | DATE                | 11/02/2011          | MATERIAL: MILD STEEL                           | Sheet Scale: 1:5 |
| APPROVED   |             |                     |                     | PART REF: ROOFLIGHT GA - OPEN                  | SHEET 3 OF 3     |
| <b>LUMEN ROOFLIGHT</b>   |             | TEL. (08453) 308859 | FAX. (08453) 307260 | TITLE: CONTEMPORARY ROOFLIGHT GENERAL ASSEMBLY |                  |
| UNLESS OTHERWISE SPECIFIED DIMENSIONS ARE IN MILLIMETERS<br>ANGLE ±0.5° / 0.0 ±0.25mm / 0.00±0.1mm / 0.000 ±0.05mm |             |                     |                     | SIZE: DRWG No.                                 | Rev No.          |
|  |             |                     |                     | A3 TUS0997A                                    | <b>2</b>         |

